

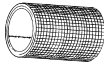









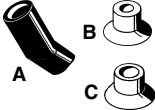

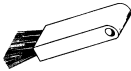

















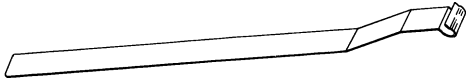







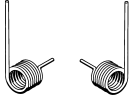





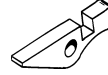

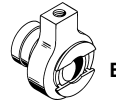

Replacement parts for: HAMADA 500CDA, 600CD, 600AT, 601CD/QT, 602CD/QT,

	PART #	PRICE
	SCREEN ASSEMBLY For compressor filter bottle 500, 600, 700 P-55033	39.90
	V-BELTS For Hamada For compressor (115V, 50/60 Hz) P-1680 (27") 5.90 For compound pulley to machine P-1686 (30") 6.50 Intermediate P-4930 (36") 11.95 Drive shaft (60 Hz) P-1678 (28") 5.90 Main drive P-4933 (39") 11.95 Main drive P-4934 (38") 11.95 Main drive P-5457 (37") 11.95 *** All sizes available 2L, 3L, 4L, 5L	
	SUCKER FOOT (A) Standard P-5207 2.50 (B) Heavy P-5205 1.95 (C) For 611 P-5206 2.25	
	SUCKER FOOT HOLDER P-55174 7.10	
	FEED BRUSH P-31170 12.90	
	FEEDER CLAMP P-55049 19.95	
	FEEDER CLAMP - 611, 612 P-66087 67.95	
	BUMPER P-5590 2.40	
	FEEDER PULLOUT ROLLER 500, 700 P-55125 59.90 600, 601, 602, 800 P-66125 108.15	
	SPRING For feed roll tire P-55386 2.95	
	SLEEVE For inside of pullout roller bearing P-55384 21.90	
	BEARING ASSEMBLY For lower feed roller 500 PF P-3201 28.95	
	SHEET SEPARATOR P-12114 .80	
	BRACKET For sheet separator holder P-55113 15.90	
	THUMB SCREW For sheet separator holder P-2900 7.95	

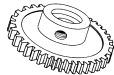
	PART #	PRICE
	TABLE RAISE HANDLE ASSEMBLY *** MADE WITH DURABLE WHITE BRASS FOR LONGER LIFE & DURABILITY. Complete P-12955 99.90 (A) Screw P-874 .40 (B) Nut P-492 .40 (C) Ball (inside) P-755 2.25 (D) Spring (inside handle) P-12909 2.90 (E) Handle P-36961 19.90 (F) Shaft P-36962 16.90 (G) Spring lock P-36959 3.70	
	BLOCK For blower nozzle P-55164 11.95	
	SPRING For paper feed adjusting shaft P-55148 2.50	
	HEIGHT CONTROL LEVER P-55782 24.95	
	SPRING For paper height bar 700 P-77711 3.75	
	CONVEYOR TAPE P-1796 10.75	
	CONVEYOR TAPE GUIDE P-12286 3.25	
	PAPER RETAINER P-12433 19.90	
	CONVEYOR JOGGER BLOCK P-55200 9.95	
	JOGGER CAM LINK P-55443 19.95	
	SPRING For conveyor spring guide 800DX, SX P-80496 2.50	
	FEED ADJ. KNOB P-11541 12.90 STOP For adjusting nut P-12606 2.95	
	SHAFT For clutch pulley P-55614 18.90	

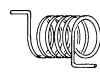
THIS IS JUST A SAMPLE OF OUR TOTAL INVENTORY

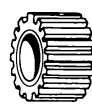
611, 612,700CD, 800DX/SX, 50/60/70/80

	PART NO.#	PRICE		PART NO.#	PRICE
	SPRINGS For impression cylinder shaft P-55213 P-55406	4.95 3.95		INK DOG & WORM KIT P-55874 Consists of dog, worm, and pin for worm.	61.95
	IMPRESSION GRIPPER FINGER P-55245	3.95		CAM FOLLOWER For ink oscillator 500, 600, 700 P-11168	59.90
	COUNTER ASSEMBLY P-55954	91.90		WATER DUCTOR ARMS 14MM Bore (L.H.) P-7727607 34.95 14MM Bore (R.H.) P-7727321 34.95 12MM Bore (L.H.) P-5525607 31.95 12MM Bore (R.H.) P-5525321 31.95	
	BLOCK For blanket bar P-55922	46.95		LATCH For form roll handle P-55538	16.90
	BLANKET CLAMP SHAFT 700 P-77308	24.90		SPRING For form roll latch P-55119	1.20
	SHAFT - MASTER CYLINDER GEAR LOCK 500, 500CD P-55180 64.90 500CDA, 600CDA P-66180 28.90 700CD P-77180 23.90			FORM ROLLER BLOCKS (A) 5/6/700 (Dampening) P-55451 35.90 (A) 5/6/700 (Lower ink) P-55431 35.90 (A) 800 (1st. ink drive) P-80451 24.90 (A) 800 (2nd. ink drive) P-80431 41.50 (A) 800 (3rd. ink drive) P-80509 41.50 (A) 800 (Dampening) P-80824 24.90 (A) 800 (Dampening) P-80889 71.20	
	NUT For master cylinder gear lock shaft P-55186	4.25		(A) 50,60,70,80 2nd. Head (Dampening) P-5524510 23.90 (B) 5/6/7/800 (Dampening) P-55415 29.90	
	MASTER CYLINDER CLAMP ADJUSTMENT Thumb screw P-2922 10.90 Thumb nut P-2942 13.95			SPRING Between ink form roller brackets P-55475	1.80
	SHAFT KEY P-55182	2.90		INK DUCTOR ARM P-55572	16.90
	WATER STOP P-30220	4.95		DUCTOR ROLLER LATCH Ink P-55338 4.95 Water P-55546 5.80	
	GEAR For dampening form roller P-55046	79.90		DUCTOR ROLLER SPRINGS Non operators side P-55331 1.95 Operators side P-55336 1.95	
	WATER PAWL P-55462	11.95		DUCTOR SHAFT SPRINGS R.H. 500, 600, 700 P-55549 1.80 L.H. 500, 600, 700 P-55567 1.80	
	WATER PAWL SPRING P-55267	1.20		PILOT SCREW For ink & water ratchet P-6509	4.95
	DOG & WORM (Water) P-55429 72.95 DOG (500, 600, 700) P-55428 27.95 WORM (Ink & water 500, 600, 700) P-55464 44.90 P-55874 61.95 DOG & WORM (Ink) P-55874 61.95 DOG (8MM Thick head) (Ink 500, 600, 700) P-55463 27.95 WORM (Ink & water 500, 600, 700) P-55464 44.90			DRIVE DOG (9MM Thick head) For second color unit P-5525463	29.95
				IDLER GEAR (BRASS) For night latch P-55457	79.90
				IDLER GEAR (STEEL) Contacts distributor roller P-55446	69.90
				GRIPPER FINGER P-241000	7.95
				GRIPPER FINGER (with pin) P-801024 32.85 GRIPPER FINGER (w/o pin) P-801025 25.80	



★★★ Hardness density has been improved so that the dog and worm wear evenly.

THIS IS JUST A SAMPLE OF OUR TOTAL INVENTORY

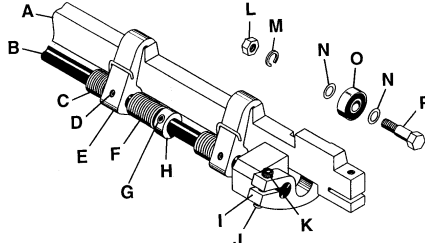
Replacement parts for HAMADA

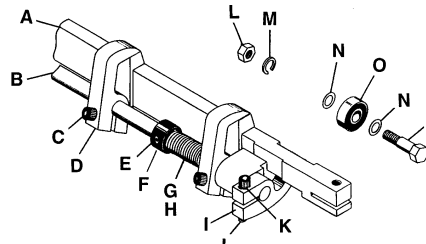
	PART #	PRICE
		
GRIPPER BAR ASSEMBLY		
Complete 500CDA, 600	P-550990	272.95
Complete 800DX, 800SX	P-800990	376.95
(A) Anvil (500CDA, 600)	P-551090	165.70
(A) Anvil (800)	P-801090	221.95
(B) Shaft (500CDA, 600)	P-551060	34.95
(B) Shaft (800)	P-801060	94.90
(C) Gripper spring (500 use 4, 800 use 8)	P-551080	2.40
(D) Roll pin (500 use 4, 800 use 8)	P-2832	.40
(E) Gripper finger (500 use 4, 800 use 8)	P-551000	7.95
(F) Gripper tension spring (1 for 800 only)	P-771080	2.40
(G) Set screw	P-2506	.45
(H) Collar (500 use 1, 800 use 3)	P-6728	3.80
** Lever assembly (consists of items (I) - (P))	P-551040	32.95
(I) Gripper operating lever	P-551041	26.95
(J) Screw	P-2107	.30
(K) Lockwasher	P-2701	.40
(L) Nut	P-2602	.40
(M) Lockwasher	P-631	.40
(N) Washer	P-2729	1.25
(O) Ball bearing	P-1803	5.90
(P) Shoulder screw	P-8160	7.95

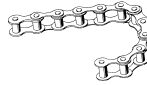
		
GRIPPER BAR ASSEMBLY		
Complete 700CD	P-770990	372.95
(A) Anvil	P-771090	221.95
(B) Shaft	P-771060	47.95
(C) Screw	P-2107	.30
(D) Gripper finger (use 7)	P-661020	14.95
(E) Set screw (use 3)	P-2506	.45
(F) Collar	P-6728	3.80
(G) Gripper spring (on operators side use 1)	P-551081	2.40
(H) Gripper spring (on non-operators side use 1)	P-771080	2.40
** Lever assembly (consists of items (I) - (P))	P-551040	32.95
(I) Gripper operating lever	P-551041	26.95
(J) Screw	P-2107	.30
(K) Lockwasher	P-2701	.40
(L) Nut	P-2602	.40
(M) Lockwasher	P-631	.40
(N) Washer	P-2729	1.25
(O) Ball bearing	P-1803	5.90
(P) Shoulder screw	P-8160	7.95

	CHAIN		
	500, 600, 800	P-8937	136.95
	700 (delivery-set of 2)	P-8936	136.95
	(side jogger 1 only)	P-8908	19.95
	GRIPPER CHAIN		
	601, 602CD/QT (1 only)	P-8958	76.95
	CHAIN JOINT ASSEMBLY		
	Carrier link	P-5345	7.50

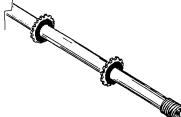
	PART #	PRICE
		
STAR BAR ASSEMBLY		
600	P-663010	8.50
700	P-773010	11.50

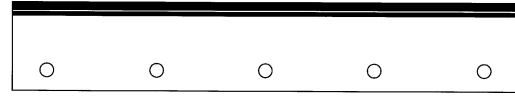
		
CLEAN UP BLADES		
(black rubber)	P-30214	34.95
800 SX & DX	P-30215	39.95
611, 612	P-30204	39.95
660 2nd. head	P-30213	49.95
500 2nd. head	P-30306	49.95
700 1st. head	P-30248	39.95
700 2nd. head	P-30223	49.95
880 2nd. head	P-30215	39.95
RS, VS 34	P-31300	52.90

		
TINSEL		
Hamada 500, 600, 700		
10 Feet	P-36658	12.90
72 Feet	P-36673	52.00

	SPRING For 500CDA, 600CD Water guard	
	P-77545	4.55

	DELIVERY STRIPPER FINGER	
700	P-772282	6.95

	STRIPPER FINGER	
800	P-802281	6.95

	STRIPPER FINGER For chain delivery	
All models	P-552281	5.95
Screw	P-2407	.55
Washer	P-2701	.40

	STEEL STRIP For perforating unit	
800DX/SX	P-803130P	6.95

*** Eliminate costly downtime with your own emergency kit for your model press.

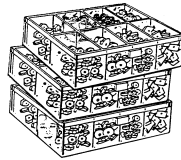
	REPAIR KITS FOR HAMADA	
Master kit	P-30376 - 513 pcs.	199.95
Pin kit	P-30375 - 168 pcs.	59.95
Ring kit	P-30374 - 103 pcs.	29.95
Nut kit	P-30373 - 42 pcs.	19.95
Washer kit	P-30372 - 68 pcs.	49.95
Screw kit	P-30371 - 132 pcs.	59.95

THIS IS JUST A SAMPLE OF OUR TOTAL INVENTORY